

Article number: 439500260

Description: Rota-fix shaft-hub connection F260x325  
Steel

Note: Self centering. Very high torque

## Measures

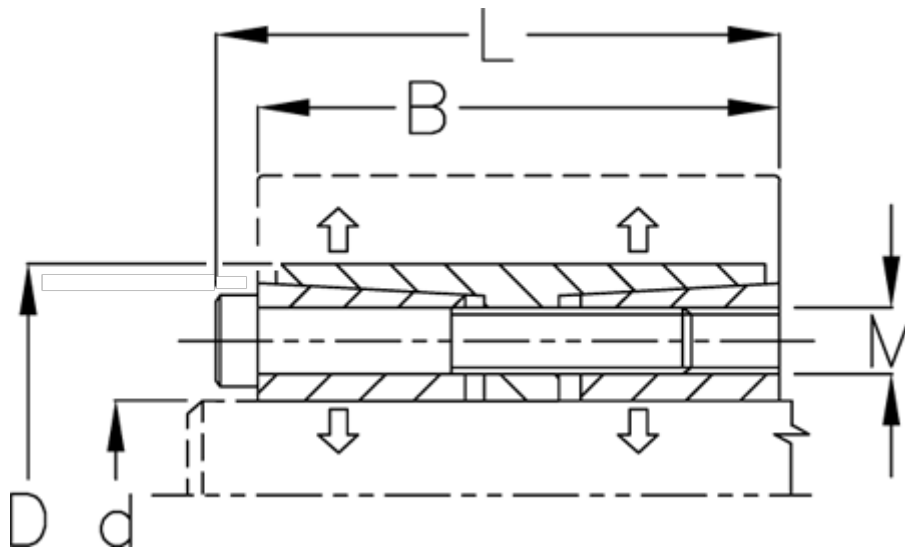

B mm	= 150
d H8 mm	= 260
D mm	= 325
Fit tolerance	= Aksel h8, Nav H8
F kN torque	= 1760.0
L mm	= 166
M mm	= M16
P N/mm <sup>2</sup> surface pressure on shaft/hub	= 110

Surface roughness	= R? ? 3.2 µm
T N m torque	= 228000
Ts N m bolt tightening torque	= 355.0